

MODELS

Natural Gas	Description	Propane
FPB-19RBSTFS-N	19" Round Stainless Pan & Spur Kit	FPB-19RBSTFS-P
FPB-25RBSTFS-N	25" Round Stainless Pan & Spur Kit	FPB-25RBSTFS-P
FPB-29RBSTFS-N	29" Round Stainless Pan & Spur Kit	FPB-29RBSTFS-P
FPB-33RBSTFS-N	33" Round Stainless Pan & Spur Kit	FPB-33RBSTFS-P
FPB-20SBSTFS-N	20" Square Stainless Pan & Spur Kit	FPB-20SBSTFS-P
FPB-26SBSTFS-N	26" Square Stainless Pan & Spur Kit	FPB-26SBSTFS-P
FPB-32SBSTFS-N	32" Square Stainless Pan & Spur Kit	FPB-32SBSTFS-P
FPB-38SBSTFS-N	38" Square Stainless Pan & Spur Kit	FPB-38SBSTFS-P

Outdoor Thermocouple Flame Sense (TFS) Fire Pits

Installation and Operating Instructions

IF YOU CANNOT READ OR UNDERSTAND THESE INSTALLATION INSTRUCTIONS DO NOT ATTEMPT TO INSTALL OR OPERATE THIS APPLIANCE

INSTALLATION PRECAUTION:

This fire pit requires a minimum 18-square inches (per side) of cross ventilation. Failure to provide proper ventilation can void the warranty.



Warning: For Outdoor Use Only



We recommend that our gas hearth products be installed and serviced by professionals who are certified in the U.S. by the National Fireplace Institute® (NFI) as NFI Gas Specialists.

PLEASE RETAIN THIS MANUAL FOR FUTURE REFERENCE



DANGER

CARBON MONOXIDE HAZZARD

This appliance can produce carbon monoxide which has no odor.



Using it in an enclosed area can kill you.

Never use this appliance in an enclosed space such as a camper, tent, car or home.



DANGER

If you smell gas:

1. Shut off gas to the appliance.
2. Extinguish any open flame.
3. If odor continues, keep away from the appliance and immediately call your gas supplier or fire department.



WARNING

Do not store our use gasoline or other flammable vapors and liquids in the vicinity of this or other appliances.

Any LP cylinder not connected for use shall not be stored in the vicinity of this or other appliances.

WARNING

Do not leave unattended during use.
Do not use for cooking.
Follow all gas leak procedures in this manual prior to operation.



WARNING

Improper installation, adjustment, alteration, service or maintenance can cause injury of property damage. Read the installation, operating and maintenance instructions thoroughly before installing or servicing this equipment.

WARNING

If the information in these instructions is not followed exactly, a fire or explosion may result causing property damage, personal injury or death.

FOR YOUR SAFETY

Do not store or use gasoline or other flammable vapors and liquids in the vicinity of this or other appliance.



Fuels used in gas fired appliances, and the products of combustion such as fuels, contain chemicals known to cause cancer, birth defects and/or other reproductive harm.
This warning is issued pursuant to the California Health & Safety Code Sec. 25249.1

CALIFORNIA PROPOSITION 65



WARNING

This product can expose you to Chromium, which is known to the state of California to cause cancer and birth defects or other reproductive harm.
(For more information, go to www.p65warnings.ca.gov)

TABLE OF CONTENTS

Specifications	3
Preparation for Non-Combustible Structure	4
Hard Piping to Fire Pit	5
Cross Ventilation Requirements	5
High Elevation	5
Installation into an Approved Enclosure	6
Typical Installation Drawings	6
Gas Pipe Sizing Chart	7
Final Preparations	6
Installing Battery Pack	8
Installation of Lava Rock/Media	9
Learning Remote Control to Module (Receiver)	9
Operation	10
Lighting Instructions	10
Replacement Parts	11
Replacement Parts List	12
Fire Pit Maintenance	13
Trouble Shooting	13-15
Optional Accessories	15-16



All media (i.e. lava rock, lava stones, lava boulders and fire glass) has the potential of thermal spalling. This is a process that may occur when media is wet and moisture gets trapped inside of the material due to rapid temperature differences. When this happens the media has the potential to crack or “pop” outside the fireplace.

WE HIGHLY RECOMMEND COVERING ALL FIRE FEATURES WHEN NOT IN USE

The use of a cover can lessen the impact of thermal spalling; however, heavy rains, high humidity and the presence of moisture may still cause the media to pop.

ALWAYS USE CAUTION WHEN USING THE FIRE FEATURE

Extra caution should be taken when lighting a fireplace when heavy rains, high humidity and moisture are present. Light the fireplace; leave the area allowing any moisture in the media to dissipate. We strongly recommend that during this drying out time that you monitor the fire feature from a distance. This drying out period should be no less than 30 minutes. Continue monitoring the flame from distance to ensure that all popping has ceased before fully enjoying the fire.

TFS SPECIFICATIONS

Model: Natural Gas (NG)	Model: Propane Gas (LP)	A Pan Depth	B Min/Max Install Opening	C Inside Pan	D Ground Level	E Side Wall	F Combustible Ceiling	G Combustible Floor
FPB-19RBSTFS-N	FPB-19RBSTFS-P	2 3/4"	19 1/4" - 21 1/2"	19"	18"	16"	54"	18"
FPB-25RBSTFS-N	FPB-25RBSTFS-P	2 3/4"	25 1/4" - 27 1/2"	25"	18"	19"	69"	18"
FPB-29RBSTFS-N	FPB-29RBSTFS-P	2 3/4"	30" - 31 1/4"	29"	18"	19"	69"	18"
FPB-33RBSTFS-N	FPB-33RBSTFS-P	2 3/4"	34" - 35 1/4"	33"	18"	19"	69"	18"
FPB-20SBSTFS-N	FPB-20SBSTFS-P	2 3/4"	20 1/4" - 1 3/4"	20"	18"	16"	54"	18"
FPB-26SBSTFS-N	FPB-26SBSTFS-P	2 3/4"	26 1/4" - 27 3/4"	26"	18"	19"	69"	18"
FPB-32SBSTFS-N	FPB-32SBSTFS-P	2 3/4"	32 1/4" - 33 3/4"	32"	18"	19"	69"	18"
FPB-38SBSTFS-N	FPB-38SBSTFS-P	2 3/4"	38 1/4" - 39 3/4"	38"	18"	19"	69"	18"

Table 1 Fire Pit Dimensions

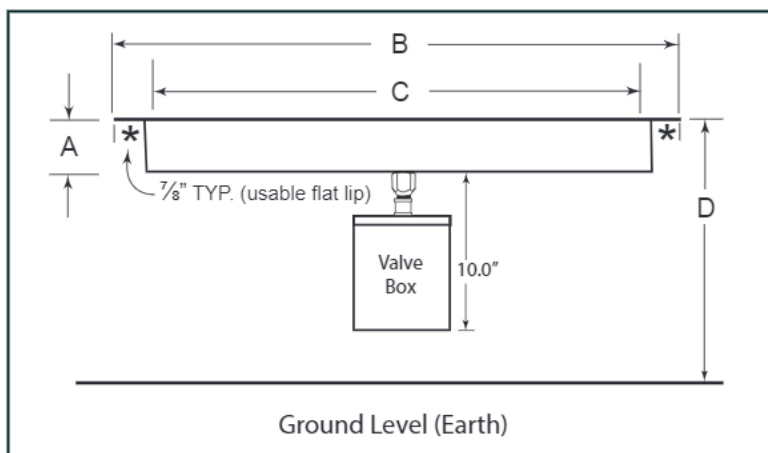

Fig 1. Fire Pit dimensions; refer to Table 1. (Dimensions applicable to round or square pans)

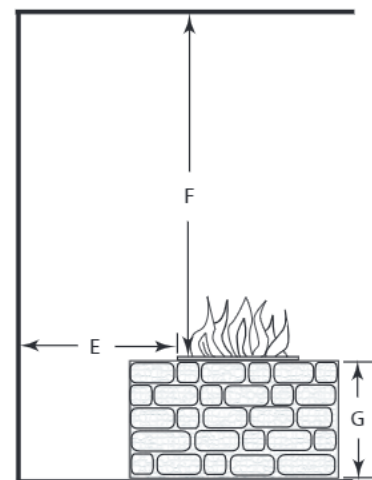

Fig 2. Clearance to Combustibles (Not to be used in an enclosed space)

Model: TFS Natural Gas (NG)	NG Factory Orifice	NG BTU's High	NG BTU's Low	Model TFS Propane (LP)	LP Factory Orifice	LP BTU's High	LP BTU's Low
FPB-19RBSTFS-N	#19	80,000	45,000	FPB-19RBSTFS-P	#36	79,000	47,400
FPB-25RBSTFS-N	#7	105,000	51,000	FPB-25RBSTFS-P	#31	100,000	49,500
FPB-29RBSTFS-N	#7	105,000	51,000	FPB-29RBSTFS-P	#31	100,000	49,500
FPB-33RBSTFS-N	#7	105,000	51,000	FPB-33RBSTFS-P	#31	100,000	49,500
FPB-20SBSTFS-N	#19	80,000	48,000	FPB-20SBSTFS-P	#36	79,000	47,400
FPB-26SBSTFS-N	#7	105,000	51,000	FPB-26SBSTFS-P	#31	100,000	49,500
FPB-32SBSTFS-N	#7	105,000	51,000	FPB-32SBSTFS-P	#31	100,000	49,500
FPB-38SBSTFS-N	#7	105,000	51,000	FPB-38SBSTFS-P	#31	100,000	49,500

Table 2. Btu Specifications

Disclaimer: BTU listings are based on 7.0"WC for Natural Gas and 11.0"WC for Liquid Propane (LP) to the gas valve. Flex line size and proper gas pipe sizing will also affect BTU. As a result your BTU may vary slightly from Table 2 specifications.

Pressure	NG	LP
Min. Inlet	5.0" WC	10.5" WC
Max. Inlet	10.5" WC	13.0" WC
Normal Inlet	7.0" WC	11.0" WC

Table 3. Gas Pressures



WARNING: Proper clearances from combustible, construction materials must be maintained from all sides, top and bottom of this appliance. Use the specifications listed on page 3 for proper clearance to combustibles.

PREPARING A NON-COMBUSTIBLE STRUCTURE

The fire pit can be installed on a flat, stable surface, away from any combustible materials. Install fire pit on any level, outdoor non-combustible, flat, stable surface or a combustible floor according to the clearances specified in this manual.

NOTE: Do not place fire pit directly on grass, dirt, or rocks this may prevent proper ventilation (Fig. 3, pg. 4).

Ensure proper water drainage is also incorporated into the fire pit enclosure.

HARD PIPING TO FIRE PIT WITHOUT GAS PROXIMITY

NOTE: Refer to the NFPA54 (National Fuel Gas Code) for proper pipe sizing. See gas line sizing chart on page 6 as a reference.

1. Turn **OFF** gas supply system. **NOTE:** All gas connections (except for brass to brass) require the following. Clean pipe threads using either a wire brush or steel wool. Apply pipe sealant to the fittings before making any connection.
2. **BE CAREFUL!** Ensure all gas connections are snug, but do not over tighten!
3. Consult a plumber for proper installation to ensure you are providing adequate gas supply for your application.
4. The primary gas shut-off (not supplied) will require a ½" male flared fitting to enable connection of the stainless steel flex gas line supplied with the fire pit.
5. Do not place an LP tank inside any fire pit enclosure. Locate all propane (LP) tanks outside the enclosure.
6. To prevent performance problems in Propane (LP) fire pits, do not use a Propane tank less than 100lbs. capacity.

IMPORTANT

Installation of Natural or LP gas should be done by a qualified installer, service agency or gas supplier. This appliance must be isolated from the gas supply piping system by closing its manual shutoff valve during any pressure testing of the gas supply piping system at test pressures equal to or less than ½ "psig (3.5kPa)

VENTILATION FOR NON-COMBUSTIBLE ENCLOSURE

Fire pits are subjected to many outdoor elements such as rain, snow, wind, heat or cold. **A minimum of 18 square inches of cross ventilation (2 sides) is required to keep the components in good working order.** Use figure 3 as guide

HIGH ELEVATION INSTALLATION

This appliance is listed for elevations from 0- 4500 feet in Canada and the U.S. If elevation exceeds 4500 feet it may be necessary to decrease the input rating by changing the existing burner orifice to a smaller size. Input should be reduced 4% for each 1000 feet beyond the 4500 feet above sea level. Check with your local gas utility for assistance in determining the proper orifice in your location. In some cases the heating value may already be reduced and downsizing the orifice may not be necessary. Refer to NFPA54 Table E.1.1(d) for high altitude orifice sizing.

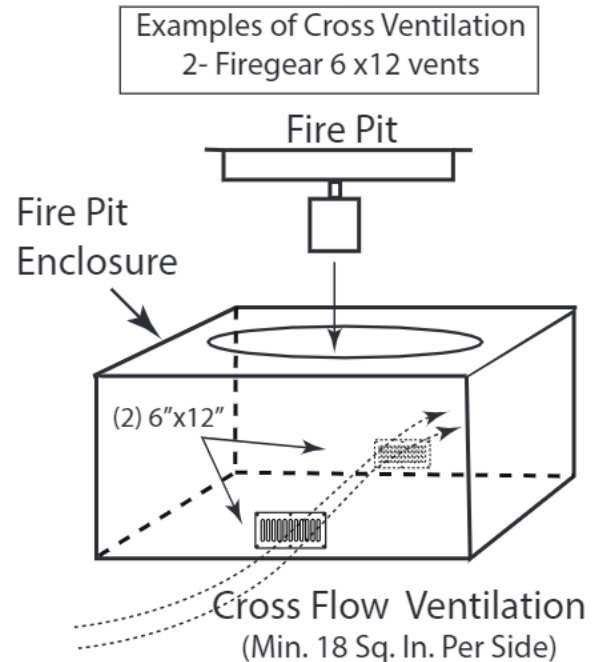

Fig 3. Cross Ventilation Example

INSTALLATION OF FIRE PIT INTO AN APPROVED ENCLOSURE

REQUIREMENTS

1. Only non-combustible materials should come in direct contact with any part of the fire pit. Underneath area should be non-combustible or a flat level combustible surface according to the clearances specified in this manual.
2. Refer to the NFPA54 (National Fuel Gas Code) for proper pipe sizing (See Table 4, page 7).
3. Determine the size of the round or square fire pit you are preparing to install (Refer to page 3).
4. You must provide a round or square cut out to place the fire pit into the non-combustible enclosure. Use the pattern from the shipping carton for sizing.
5. Follow the local code requirements for the gas type being used. This fire pit should be installed in accordance with local codes and ordinances or in the absence of local codes, with the latest National Fuel Gas Code, ANSI Z223.1 NFPA54 or CSA B149.1, Natural and Propane Installation Code in Canada.
6. Fire pits create high temperatures, it is very important to have any combustibles at a safe distance.
7. Normal operation of the fire pit is with a battery pack that is supplied with your system (Fig 4). The battery pack has 12-feet of black sleeved wire that is to be passed through the junction box provided. This wire should not be cut or spliced and the junction box can be placed in the facing of the vertical finish of the fire pit, if you place the wire under ground you should install those wires into an approved protective conduit/sleeve material.
8. Fire pit should never be left unattended while in operation. It should always be a safe distance from all trees and combustible landscape materials.
9. Construction of the finished fire pit should be stable and solid. From the bottom of the control box that houses the gas valve and module, it should be a minimum of 8-inches to the ground level. See Fig 1. Drainage is critical to ensure that water does not damage gas valve and components. Never install the fire pit system below grade.
10. **CAUTION: A minimum of 18 square inches of cross ventilation (per side) is required to keep the inside of the enclosure dry. We recommend installation of a VENT-KIT-6x12.**
11. Never fill the cavity under and around the valve box with any material, this is a provided air space necessary for ventilation.
12. These products are designed for outdoor use only. Not approved for any indoor use.
13. This fire pit is designed to have decorative rock, lava rock/Media covering the burner, so the burner is not visible. Optional concrete logs can be added to consumers taste. Decorative Rock is not provided. When purchasing decorative rock use minimum of 1 to 2-inch diameter rock as a base to fill the burner pan. **DO NOT COVER THE IGNITION HOOD WITH ANY ROCK OR MEDIA.**
14. Gas lines and fittings must be installed in to the non-combustible structure. All gas connections must be leak tested before installation of the fire pit. Soapy water leak detection is required before regular use of the fire pit.
15. Do not use material that will absorb moisture over time and will not release this moisture quickly. Moisture can boil in this material and can rapidly break apart and cause damage or personal injury.
16. Never leave any other combustible material on top of the fire pit. This could cause unsafe operation of this system and damage to the component that will not be covered under our warranty.

NOTE: Gas valve, flexible gas lines and TFS components are supplied. Gas shut-off is not supplied. See accessory page 13.

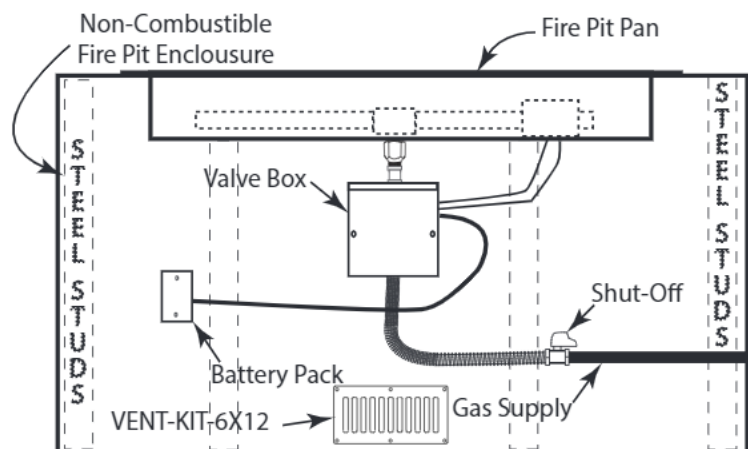

Fig. 4 Typical installation.

GAS PIPE SIZING CHART

NATURAL GAS : PIPE SIZING CHART

Length of Pipe in Feet	1/2"	3/4"	1"	1 - 1/4"	1 - 1/2"	2"	2 - 2 1/2"	3"	4"
10	108	230	387	793	1237	2259	3640	6434	-
20	75	160	280	569	877	1610	2613	5236	9521
30	61	129	224	471	719	1335	2165	4107	7859
40	52	110	196	401	635	1143	1867	3258	6795
50	46	98	177	364	560	1041	1680	2936	6142
60	42	89	159	336	513	957	1559	2684	5647
70	38	82	149	317	476	896	1447	2492	5250
80	36	76	140	239	443	840	1353	2315	4900
90	33	71	133	275	420	793	1288	2203	4667
100	32	68	126	266	411	775	1246	2128	4518
125	28	60	117	243	369	700	1143	1904	4065
150	25	54	105	215	327	625	1008	1689	3645
175	23	50	93	196	303	583	993	1554	3370
200	22	47	84	182	280	541	877	1437	3160
300	17	37	70	145	224	439	686	1139	2539

- Natural Gas (NG) flow is given in thousands of BTU/hr. = 1 cubic foot of NG gas - 1000 BTU
- Nominal pressure at the burner for Natural Gas is 3.5" of water column. (Typical machine supply 5"-7")
- Pipe length must include additional length for all fittings. Add approximately 5 feet of pipe per fitting.
- Natural Gas Example: A machine with a burner that requires 440,000 BTU would need a 1 -1/4" pipe for a 20" long run.

LIQUID PROPANE : PIPE SIZING CHART

Length of Pipe in Feet	1/2"	3/4"	1"	1 - 1/4"	1 - 1/2"	2"	2 - 2 1/2"	3"	4"
10	275	567	1071	2205	3307	6221	10140	17990	35710
20	189	393	732	1496	2299	4331	7046	12510	25520
30	152	315	590	1212	1858	3465	5695	10110	20620
40	129	267	504	1039	1559	2992	4778	8481	17300
50	114	237	448	913	1417	2646	4343	7708	15730
60	103	217	409	834	1275	2394	3908	6936	14150
70	89	185	346	724	1086	2047	3329	5908	12050
80	78	162	307	630	976	1811	2991	5309	10830
90	69	146	275	567	866	1606	2654	4711	9613
100	63	132	252	511	787	1496	2412	4281	8736
125	54	112	209	439	665	1282	2083	3618	7382
150	48	100	185	390	590	1138	1808	3210	6549
175	43	90	168	353	534	1030	1637	2905	5927
200	40	83	155	325	491	947	1505	2671	5450
300	37	77	144	303	458	887	1404	2492	5084

- Liquid Propane (LP) Gas flow is given in thousands of BTU/hr. = 1 cubic foot of LP gas - 2500 BTU.
- This chart refers to low pressure LP, after regulation. Standard nominal pressure at the burner for Liquid Propane Gas is 11" of water column.
- Pipe length must include additional length for all fittings. Add approximately 5 feet of pipe per fitting.
- LP Example: A machine with a burner that requires 440,000 BTU would need a 1" pipe for a 20' long run.

NOTE: The sizing charts above list the specific pipe sizes required for the amount of BTU's for a new gas line installations. If you are using an existing gas line you must take into consideration the existing gas line capacities to ensure you will have proper pressure. **This chart is for reference only, we recommend you consult with a Licensed Plumber/Gas Fitter or NFPA54 (National Fuel Gas Code - current edition) for more details.**



FINAL PREPARATIONS

INSTALLATION OF BATTERY PACK

It is important to locate the battery pack where it is easy to access for battery replacement and service. The best location is on the outside wall of the fire pit enclosure. A plastic junction box is provided for the installation of the battery pack and a weather-proof cover to protect it from the outside elements.

1. Install (4) AA batteries in to the battery pack by sliding the cover off as shown in Fig. 5. Double check to ensure the switch on front of the battery pack is in the latching solenoid position. Install the battery pack cover plate by snapping it into place on the back side of the white cover plate as shown in Fig 6. **Note:** Be sure the batteries are installed positive-to-positive and negative-to-negative. If one battery is installed backwards the system will not operate.
2. Install the junction box and secure into position. **Note:** Junction box should be flush with the finish materials to ensure weatherproof cover/lid has room (clearance) to open. See Fig. 7.
3. The fire pit has 12-feet of wiring outside of the valve box underneath the burner pan. One end of the wiring has a 4-pin connector. The others are (2) two individual wires (one black and one red) with ¼" female connectors.
4. Feed the wire ends into the junction box and out the front (approximately 4-6 inches) to connect to battery pack (See wiring diagram on page 14, Fig.10 and Fig. 7).
5. Open the lid of the weatherproof cover and install the white cover plate with battery pack attached into the weather proof cover and rubber gasket.
6. Connect the wires from the junction box to the battery pack. Plug the white 4-pin connector into back of the battery pack and connect the two ¼" female spade wires matching color, red-to-red and black-to-black. Leave enough "play" in the wires to allow the weatherproof cover/lid and be screwed to the junction box.
7. Secure the weatherproof cover/lid to the two outside holes at the top and bottom of the junction box.
8. Secure the white cover plate and battery pack to the center holes at the top and bottom of the junction box.
9. After the fire pit is installed into the enclosure, the burner and control system should be tested before the media (lava rock) is installed. **Note:** Flame height will be very low until media is placed into the burner pan covering the burner.

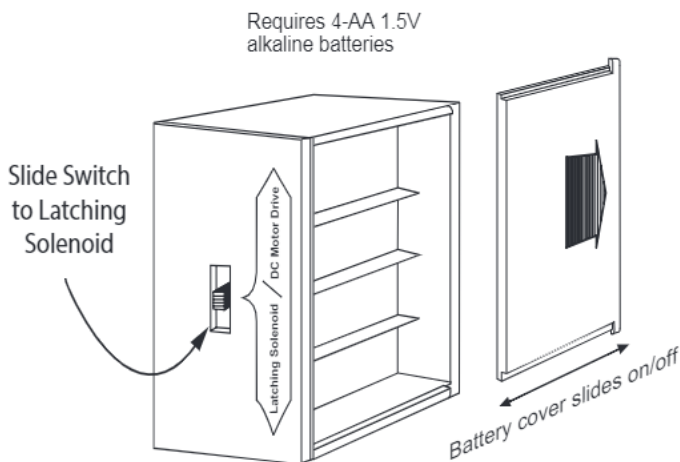

Fig. 5. Slide switch on latching solenoid

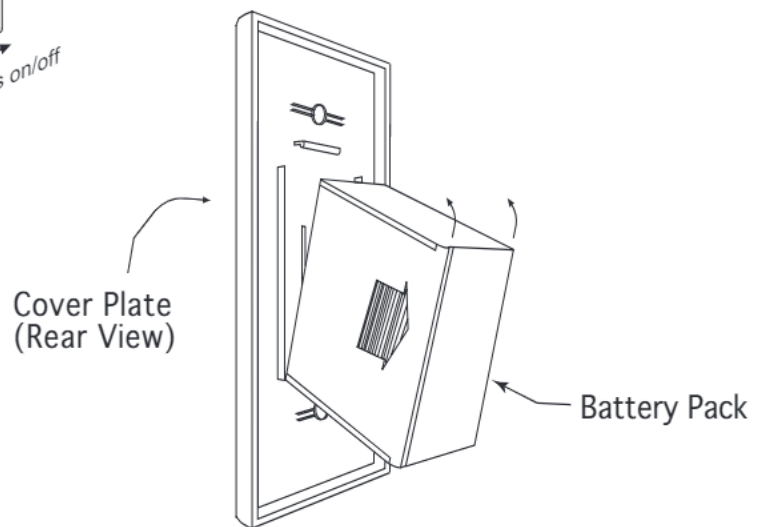

Fig. 6 Cover plate installation

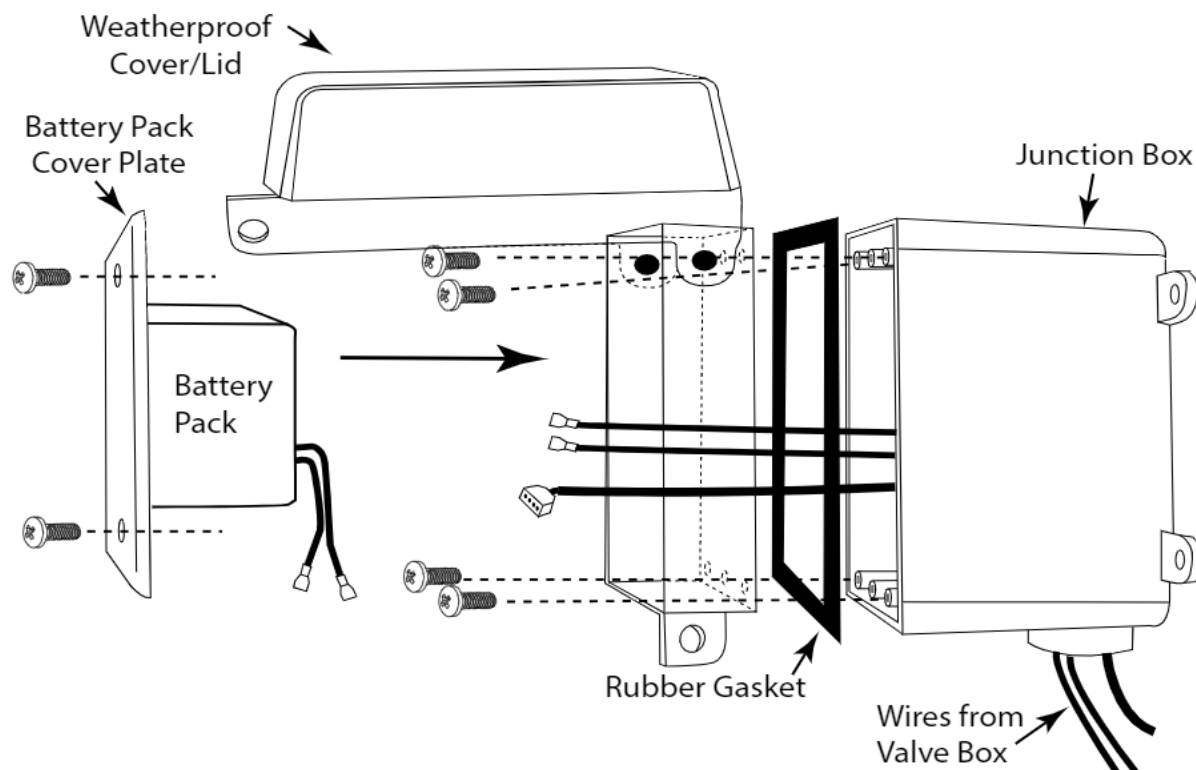

Fig. 7 Weatherproof Cover/Lid

INSTALLATION OF BATTERY INTO TRANSMITTER

You have one handheld transmitter and you will need to install the included (12-volt battery) into the transmitter. On the backside of the transmitter, push the cover away from the case. Place the battery into the compartment matching positive-to-positive and negative-to-negative. To ensure the battery is properly installed push any button on the transmitter and you will see a red LED light at the top of the transmitter glow. The red LED light will only be lit when a button is pushed.

IGNITOR ALIGNMENT

It is important check that the ignitor probes be properly aligned overtop of the burner port holes and did not move during shipping. Use the Fig. 8 as a guide. Before lighting remove the screen cover of the ignition hood to burner and ensure the spark probes are directly overtop of a burner port hole. The sparking probes and the thermocouple must be in the path of a flame to ignite the gas for proper ignition of the flame. Replace the screen cover and follow the operating instructions.

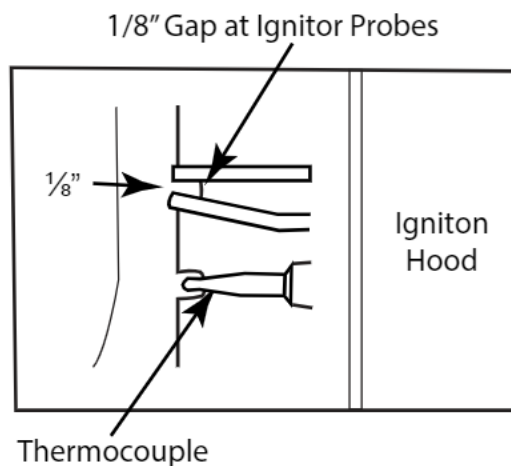

Fig. 8 Proper alignment of probes and thermocouple.

LEARNING THE REMOTE CONTROL TO THE MODULE

The fire pit is unique that it comes standard with one remote controlled transmitter. The handheld remote is shipped with this system are already learned (programmed) to the module inside the control box. Additional transmitters can be learned to this electronic module; up to a total of three transmitters are available. Contact Firegear to discuss additional transmitter options or see the accessory page of this instruction manual.

Learning the new transmitters is simple, but will require pressing the learn button on the module. You should learn any new transmitters before the final installation of the fire pit. Follow the steps below:

1. Remove the two screws securing the cover on the control box (See Fig. 9). The cover will slide down exposing the gas valve and control module.
2. Find the black module attached to the inside of the control box. Locate the "Learn Button" on the bottom of the module.
3. Once the Learn button is located, press and release the button once. You will hear a beep indicating that the module is ready to receive a transmitter code (See Fig. 10)
4. Take the transmitter and press the OFF button. You will hear a series of rapid beeps indicating the module has accepted the new code.

NOTE: A maximum of three (3) codes can be programmed to the module. After a total of three (3) codes have been programmed the memory is full and will not accept any additional codes. To clear all codes, press and hold the learn button for 10 seconds. The module will beep three (3) times indicating the memory is clear of all codes. After codes have been cleared see to Step #3 above to re-learn transmitter.

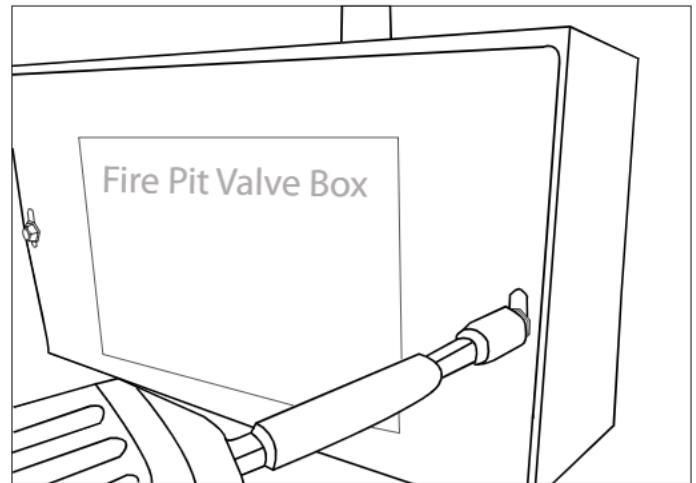

Fig. 9 Removing the cover from metal box.

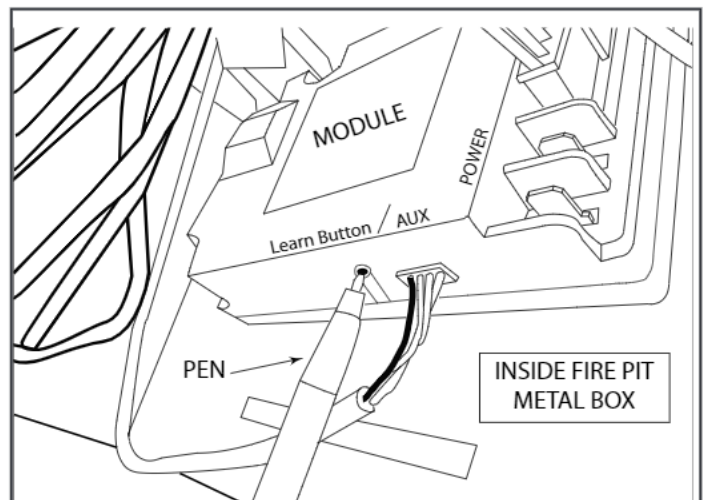

Fig 10 Learn button location

INSTALLATION OF LAVA ROCK/MEDIA INTO BURNER PAN

Install lava rock/media into the burner pan. Ensure the media is a minimum of 1 to 2-inch diameter for proper operation. **Note:** Do not pour lava rock directly from bag. Media should be placed naturally and NOT packed in tight. Loose fitting is important to ensure robust flames. Be sure rocks are free of any excessive dust. This prevents the burner pan weep holes from being plugged and holding water. **IMPORTANT:** Do not place media over top or under the screen cover. The screen must be free of any debris to ensure proper lighting of burner and to allow proper heating of the thermocouple.

Cover the burner completely with media but do not make the depth greater than 1-inch overtop of the burner portholes.

Decorative glass may be loosely scattered on top of the lava rock. Do NOT cover the stainless steel screen cover with any rock or glass. It must be free an any media/debris to operate properly.

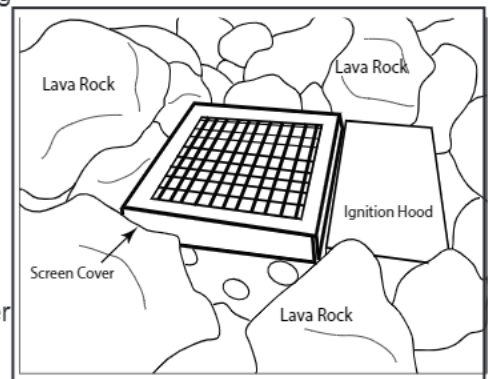

Fig. 11 Keep screen cover exposed

OPERATION

CAUTION: Children and adults should be alerted to the hazards on high surface temperatures and should stay away to avoid burns or clothing ignition. Young children should be carefully supervised when they are in the area of the appliance.

WARNING: Do not use this appliance if any part has been under water. Immediately call a qualified service technician to inspect the appliance and to replace any part of control system and any gas control, which has been under water.

SAFETY WARNINGS

1. Never leave the Fire pit unattended during operation.
2. Clothing or other flammable materials should not be placed on or near the appliance.
3. Any guard or other protective device removed for servicing the appliance must be replaced prior to operating the appliance.
4. Installation and repair should be done by a qualified service person. The appliance should be inspected before use and at least annually by a qualified service person. More frequent cleaning may be required as necessary. It is imperative the control compartment, burners and circulating air passageways of the appliance be kept clean.
5. Inspect the fuel supply connection before each use of the appliance.
6. Temporary storage of this appliance indoors is permissible only if it has been disconnected from its fuel supply (Natural or L.P. gas line).

WARNING

1. This appliance is hot when operated and can cause severe burns if contacted.
2. Do not burn any solid fuels in this appliance.

LIGHTING INSTRUCTIONS

READ ALL WARNING AND SAFETY INFORMATION ABOVE BEFORE ATTEMPTING TO LIGHT FIRE PIT

TURNING ON FIRE PIT

1. Ensure you have leak tested the fire pit before operating. Turn main gas supply ON.
2. Ensure batteries are installed in battery pack and switch is on Latching Solenoid.
3. Press the **ON** button on the transmitter. You will hear the ignitor probe will begin sparking for 15-seconds and the fire pit will turn ON.
4. If the fire pit does not light the module will “beep” one time every second indicating an ignition error. This is a hard lockout. If this occurs press the **OFF** button on the remote control and repeat step 1-3.
5. If fire pit does not light after second try turn main gas OFF, wait 5 minutes and repeat steps 1-3.

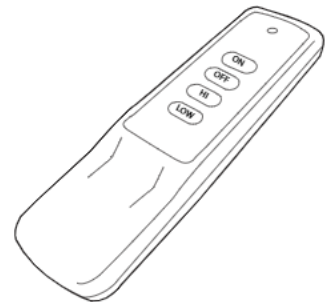

Fig. 12 Transmitter

NOTE: It may take several cycles of ON/OFF to purge the airflow from the gas lines. The direct spark ignition will turn OFF after 15 seconds if the burner does not light after which you will need to press transmitter OFF button then back ON to initiate ignition again.

Flame height is HI and LO. By pressing the buttons on the handheld transmitter you can operate ON-OFF-HI-LO. The transmitter defaults to the HI setting when initially lighting the fire pit each time but will remember the last setting used and change back to the last setting in approximately 5-seconds after lighting.

TURNING OFF FIRE PIT

1. To turn OFF the fire pit press the OFF button on the transmitter. Fire pit will turn OFF.
2. After fire pit has completely cooled off install cover.

FPB ROUND & SQUARE TFS REPLACEMENT PARTS

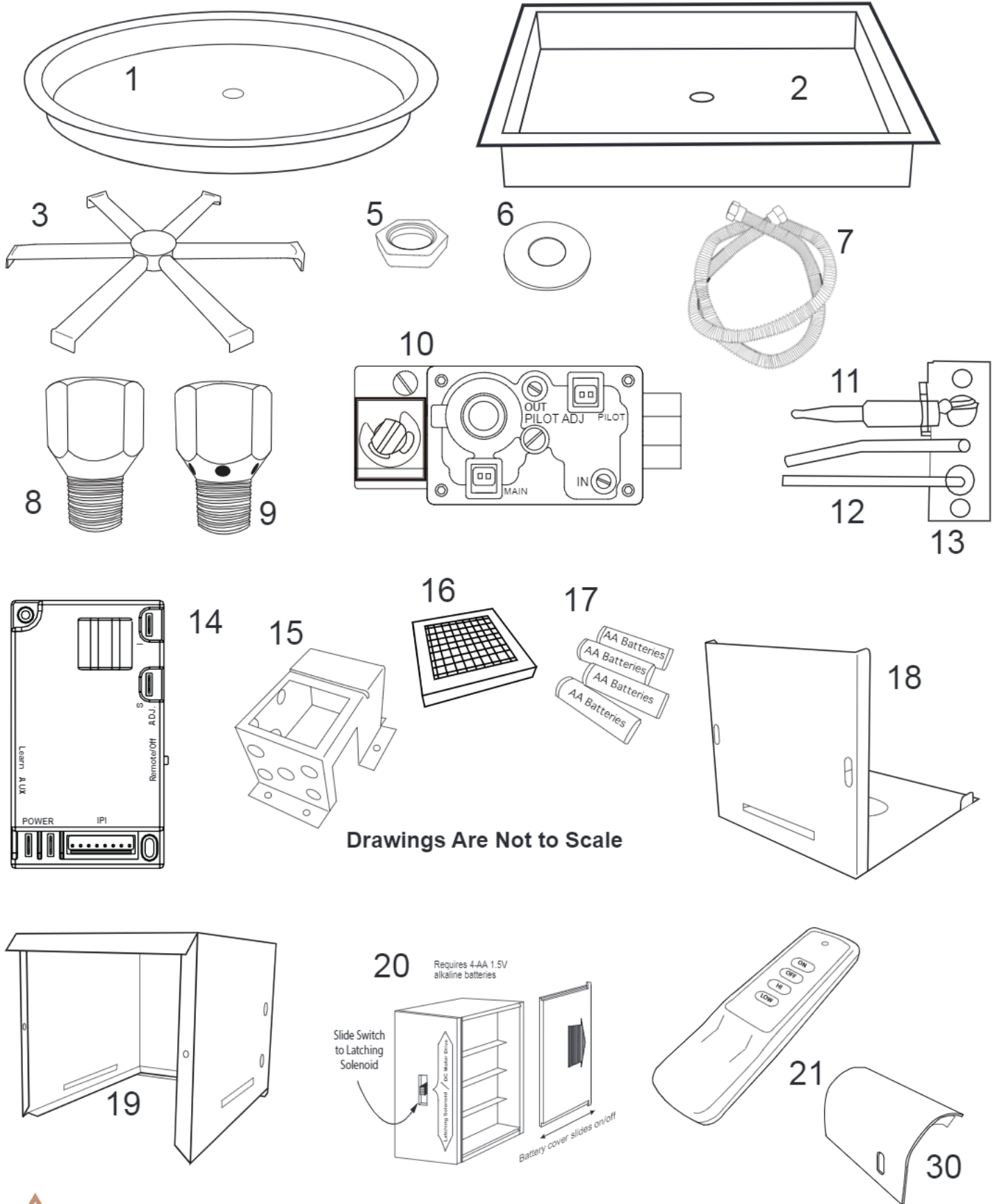

Drawings Are Not to Scale

FPB ROUND & SQUARE TFS REPLACEMENT PARTS

Item	Description	Qty.	Part Number
1	19-inch Round Stainless Pan	1	PAN-SS19R
1	25-inch Round Stainless Pan	1	PAN-SS25R
1	29-inch Round Stainless Pan	1	PAN-SS29R
1	33-inch Round Stainless Pan	1	PAN-SS33R
2	20-inch Square Stainless Pan	1	PAN-SS20S
2	26-inch Square Stainless Pan	1	PAN-SS26S
2	32-inch Square Stainless Pan	1	PAN-SS32S
2	38-inch Square Stainless Pan	1	PAN-SS38S
3	16-inch Spur (used on 19" Rd. & 20" Sq. Pans)	1	B-SPUR-16
3	22-inch Spur (used on 25", 26", 29", 32", 38" Pans)	1	B-SPUR-22
4	Red Silicone "O" Ring (not shown)	1	ORING
5	½" NPS Brass Mounting Nut	1	105-8
6	7/8" Flat Washer/Spacer	3	ST3-113-1026
7	Tranquiline 1/2" Flex Gas Line (46-inch Length)	1	T-200-9898-46
8	Orifice Air Shutter NG (Used on Natural Gas Models)	1	OAS-NG31
9	Orifice Air Shutter LP (Used on Propane Models)	1	OAS-LP45
10	Electronic IPI Gas Valve with Solenoid	1	AF-4025DSILSS0
11	Thermocouple (Must be ordered with item #13)	1	ST3-040-1023
12	Ignitor Probes	1	VCS-5000DSI2P01
13	Thermocouple Bracket (Must order with item #11)	1	VCS-5000DSIB01
14	Ignition Module	1	VCS-5000MODTC
15	Ignition Hood for Spur Burner	1	SPURHOOD
16	Mesh Screen Cover	1	ST3-100-1027
17	AA Batteries 1.5 Volt (used in battery pack)	4	BATTAA
18	Valve Box Stainless Steel Cover	1	FIREPITMETALBOXCO
19	Valve Box Stainless Steel		FIREPITMETALBOX
20	Battery Pack (with 12-foot 4-Pin, 4-wire harness, cover plate and 12-foot red & black 2-wire harness for solenoid)	1	AF-4000BP12
21	ON/OFF HI/LO Transmitter	1	RCAF-3TX UNF
22	12-volt Transmitter Battery (not shown)	1	BATT12VOLT
23	Stainless Thread Cutting Screws #10-24x ½" (not shown)	4	ST3-113-1028
24	½" Stainless Steel Coupler (not shown)	1	SS499-8
25	Gas Valve 8-Pin Wiring Harness (not shown)	1	AF-40008PIN12WH/2
26	Plastic Electrical Gang Box with Tabs (not shown)	1	JUNCTIONBOX
27	12-inch, 8-Pin Wire Harness (not shown)	1	AF-40008PIN12WH2
28	½" NPT Male to Male Close Nipple (not shown)	1	ST3-093-1025
29	½" NPT Male to ½" Male Flare Fitting (not shown)	1	U1-8D-S
30	Rain Shield for Spur Burner Leg	1	RAINSHIELD
31	Thermocouple/Ignitor/Rainshield Replacement Kit (not shown)	1	TFS-IGNT-ASSEMBLY
32	Weatherproof Junction Box with Tabs (not shown)	1	WP-JBOX
33	Weatherproof Cover/lid (not shown)	1	WP-COVER
34	6-32 x 1" Flat Head Phillips Screw - Holds WP Lid to WP-JBOX (not shown)	4	SCREW6-32X1PHFHZ

FIRE PIT MAINTENANCE

1. The fire pit should be inspected and cleaned before initial use at least annually by a qualified field service person.
2. Any component that is found faulty must be replaced with an approved component.
3. Any tampering or modifying with the fire pit is dangerous and voids all warranties.
4. During winter months in cold climates and various seasons operation the fire pit may be affected by weather conditions. It is recommended to use a cover/lid overtop of your fire pit to protect it from humid/rainy weather conditions when not in use. Heavy rains/downpours could affect the fire pit operation if not covered; if this occurs ensure you allow the fire pit time to dry out before attempting to operate. **NOTE:** If a combustible type cover is used over the fire pit when not in use be sure to remove it before operation to prevent a severe safety hazard.
5. Carbon (soot) may build up on the surface of logs (if installed) during heavy use. Sooting may also occur periodically on the screen of the ignitor hood. To clean, brush off with a dry bristle brush or cloth. Keep soot away from clothing or furniture.
6. Over time stainless steel parts can discolor when heated, usually a golden or brown hue. This discoloration is normal and does not affect the performance of the appliance.

TROUBLE SHOOTING

FAULT CODES

The VCS-5000MODTC control module has built-in error detection for several common operating fault conditions. When the control module detects an error, it will emit a series of beeps. The beeping pattern will help to determine the cause of the operating fault.

Ignition Safety (Protection for Ignition system):

Error Code: One beep every one second.

Description of Fault: Warn users if the pilot is not successfully ignited in 15 seconds.

How to Clear: Press OFF then ON buttons to re-attempt ignition.

What to Check:

1. Ensure gas supply is turned ON.
2. Ensure that the gas line is purged of air. Air is common in the gas line if the appliance has just been installed, has been disconnected then re-connected to the gas line, or if the appliance has been unused for an extended period of time.
3. Ensure there is no blockage in the gas line.
4. Make sure that the flame sensor electrode is clean. Soot buildup will insulate the electrode and will not allow for proper flame sensing.
5. Ensure orange/white leads from module are plugged into the "PILOT" connection on the valve body.
6. Ensure green/white leads from module are plugged into the "MAIN" connection on the valve body.
7. Verify lead from igniter on electrode assembly is connected to the "I" terminal on the module.
8. Verify lead from flame sensor on electrode assembly is connected to the "S" terminal on the module.
9. Verify that the black ground lead from the module is connected to a proper ground on the appliance.

Sensor Safety (Protection for Flame sensor):

Error Code: 4 Beeps every one second (Constant beeping)

Description of Fault: Warn users the flame sensor detects a flame already present when ignition sequence is initiated.

This fault will also occur if the flame sensor is shorted to ground.

How to Clear: Press OFF then ON buttons to re-attempt normal ignition.

What to Check:

1. Check if flame is actually present when valve is turned OFF (if so, replace valve).
2. Ensure that the flame sensor electrode is not touching the burner or another metal surface.
3. Check to ensure ground wire from thermocouple and module is connected to gas valve.
4. If 3-probe ignitor is exposed to excessive moisture/water it will need 24-48 hours to dry out.
6. Replace electrode assembly.
7. Replace module.

Thermal Safety (Overheat Protection):

Error Code: 4 Beeps every 2 seconds.

Description of Fault: Warn users that the modules internal temperature exceeds 170°F.

How to Clear: Module's internal temperature must cool to below 160°F and then press ON button.

What to Check:

1. Ensure that there is proper ventilation to the control module.
2. Is module located in unapproved location, too close to burner?
3. Move to cooler location.

Wireless Remote Transmitter Will Not Operate Appliance

1. Make sure that the transmitter is within the 25-foot operational range of the control module.
2. Ensure batteries in transmitter are fully charged and properly installed.
3. If using the battery pack, ensure batteries are fully charged and properly installed. Also, make sure the battery pack's 4-pin connector is securely connected to the battery pack and control module.
4. If using optional AC adapter, ensure that the AC adapter leads are securely attached to "POWER" connection on the control module. Also, ensure that the AC adapter is connected to a live 120VAC power source.
5. Ensure "Remote/Off" switch on control module is set to "Remote".
6. Ensure the control module has learned the transmitter's security code (learning section page 10).
7. Make sure that the remote transmitter is not placed/mounted to a metal surface, which will reduce the operating range.
8. Make sure that there is not a large metal obstruction between the remote transmitter and the control module.

Ignitor Electrode Sparks Frequently During Operation

1. The control module will generate a spark at the igniter electrode if the system is in the ON position, but does not sense a flame.
2. Make sure that the flame sensor electrode is clean. Soot buildup will insulate the electrode and will not allow for proper flame sensing.
3. Make sure that wind does not blow the flame off of the flame sensor. The sensor hood and the appliance media (rocks, glass, etc.) provides shielding from the wind. Ensure that the sensor hood and appliance media is properly positioned per the appliance instructions. If wind is too strong, and the flame will not maintain contact with the flame sensor, the appliance should not be operated.

Flame Modulation Will Not Work or Works Backwards

1. Ensure that the black and red leads from the battery pack are securely connected to the red and black leads from the Hi/Lo latching solenoid located on the valve body (red to red and black to black).
2. Verify that the selector switch on the battery pack is set to LATCHING SOLENOID only.
3. Check functionality with all transmitters to determine if there is an issue with the main control system or an individual transmitter. If the issue is with an individual transmitter, make sure that the batteries in both the transmitter and battery pack are installed properly and fully charged.

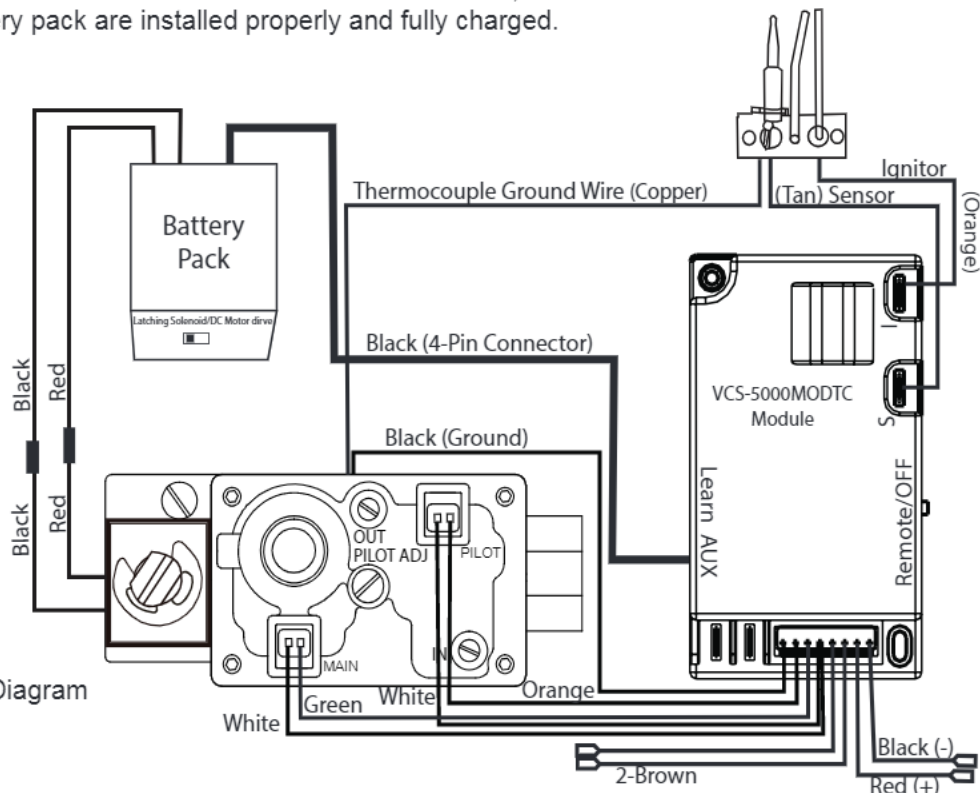

Fig. 13 Wiring Diagram

ADDITIONAL TROUBLE SHOOTING

Symptom	Remedy
Fire Pit Won't Light	<ol style="list-style-type: none"> 1. Bleed gas line. 2. Ensure all gas lines are turned ON. 3. Ensure there is not too much media overtop the burner, it can inhibit the gas flow. Too little or no media can also contribute to non-lighting. 4. Check alignment of thermocouple (TC) over rainshield on page 6, figure #7. Adjust if needed. 5. Check batteries in battery pack. Minimum total voltage to operate should be 5.3 volts.
No Spark to Ignite	<ol style="list-style-type: none"> 1. Visually look at ignitor for any physical damage. 2. Ensure batteries are not installed backwards in battery pack. Check min. voltage of 5.3 volts. 3. Ensure battery in transmitter is not installed backwards and at minimum voltage of 9.0 DCV.
Continues to Spark after Lighting	<ol style="list-style-type: none"> 1. Thermocouple out of alignment. 2. Check connection of thermocouple at "S" terminal on control module to ensure it is connected.
Low Flame	<ol style="list-style-type: none"> 1. Ensure the base media is at least 1-inch in diameter and top media is no more than 1-inch over top of burner. 2. Ensure all shut-off valves and valve is fully open. See page 5; figure 4. 3. Check for spider webs inside burner orifice.
Water in my Fire Pit	<ol style="list-style-type: none"> 1. Excess dust/sand material from media may be blocking the weep holes to relieve water. Remove all media and unplug weep holes. Clean or install new media free of dust and dirt. 2. Ensure fire pit enclosure has proper drainage for water and proper ventilation to dry out. 3. Recommend to purchase a cover/lid to keep excessive water out of the fire pit.
Whistling Noises	<ol style="list-style-type: none"> 1. Check media to ensure it is not too tightly packed around the burner tube. 2. Ensure a non-whistling flex connector is being used.
Fire Pit Won't Stay Lit	<ol style="list-style-type: none"> 1. Check alignment of thermocouple over rainshield on page 6, figure #7. 2. Thermocouple reading should be between 10-20mV. Test at the brass ground lead on gas valve and the gold lead at "S" terminal on the control module. If no minimum millivolts are maintained replace the TC. 3. Check continuity of thermocouple. Using a volt meter remove the TC test lead "S" from the control module and the brass fork terminal from the gas valve. Test for continuity. If no continuity then replace the TC. 4. Ensure thermocouple is clean and free of any debris. Excessive soot can be an issue.



OPTIONAL ACCESSORIES

The following accessories are available from your local Firegear dealer/distributor.
Each accessory comes with a separate installation manual. Read each instruction thoroughly before installing.

<p><i>Stainless Round Lids</i> for 19", 25" 29", 33" round fire pits. Models: LID-19R, LID-25R, LID-29R, LID33R</p>	<p><i>Lava Stones</i> 1" to 2" size. (50lbs.) Models: FG-LS50</p>	<p><u>LP CONVERSION KIT</u></p> <p>THERE IS NO LP CONVERSION KIT AVAILABLE THESE MODELS. YOU MUST ORDER THE FIRE PIT DIRECT FROM THE FACTORY AS PROPANE.</p>
<p><i>Stainless Square Lids</i> for 20" to 38" square fire pits. Models: LID-20S, LID-26S, LID-32S. LID-38S</p>	<p><i>Lava Rock</i> 1" to 2" size. (50lbs.) Models: FG-LAVA-50</p>	
	<p><i>Lava Boulders</i> 6" to 12" size (30lbs.) Model: FG-LB30</p>	

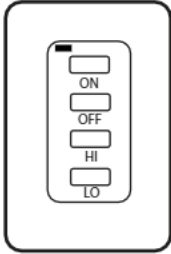
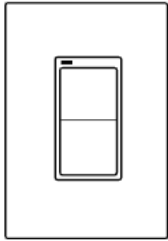

OPTIONAL ACCESSORIES CONTINUED

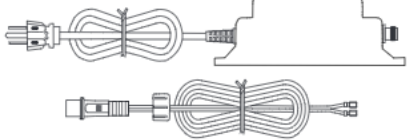
<p><i>Wireless Wall Switch</i> with ON/OFF/HI/LO MODEL: 1322-WT</p> 	<p><i>Wireless Wall Switch</i> with ON/OFF ONLY MODEL: 1001D-AF1 TX</p> 	<p><i>4-Button Timer</i> with 30/60/120/OFF Minutes MODEL: TMR-AF1 TX</p> 
<p><i>Vent Kits</i> Provide 18 sq. in of ventilation per side of enclosure)</p> <p>Model: VENT-KIT-6X12SS Model: PAVER-VENT-4LNLS Model: PAVER-VENT-6LNLS</p> <p><i>Paver Control Panels</i> PAVER-CP-MT MT systems PAVER-CO-TMSI TMSI systems</p>	<p><i>Shut-Off Valves</i></p> <p>Model: 01-387 3/8" OD Flare x 1/2" FIP Model: 01-487 1/2" OD Flare x 1/2" FIP Model: 01-266 3/8" OD Flare x 3/8" OD Flare Model: 01-288 1/2" OD Flare x 1/2" OD Flare</p>	<p><i>Power Adapters</i></p> <p>Model: ADP10-OUT (10' wire); ADP70-OUT (70' wire)</p>  <p>Outdoor approved 7.5VDC adapter/ transformer eliminates the use of battery power with any TFS system.</p>
<p><i>FLEXFRAME</i></p> <p>Universal brackets to support fire pit disc when using paver blocks or other non-combustible enclosures.</p> <p>Model: FLEXFRAME-SS</p>	<p><i>Log Sets</i></p> <p>Model: L-SF (Spit Fire) - 17pc (52lbs) L-BF (Beach Fire) 8pc (20lbs) L-Sedona (Sedona) 19pc (200lbs) 326-930 Twigs 6pc (20lbs)</p>	<p><i>Home Automation System (HAT)</i></p> <p>A transmitter compatible with home automation systems using dry contacts to operate fire pit. Model: AF4000HAT</p>

NOTE: See the Firegear Outdoors catalogue for a variety of fittings and flex connectors also available.

FOR TECHNICAL SERVICE, CALL: (855) 498-8324

Firegear Outdoors
9230 Conservation Way
Fort Wayne, IN 46809
Sales: (888) 672-8929
Sales Support: (888) 699-6167
Canadian Inquires: (877) 472-3923

Web Site: www.firegearoutdoors.com





LIMITED WARRANTY

Skytech Products Group (Firegear Outdoors) hereby warrants to the end user that products will be free from material and workmanship defects that prevent safe and correct operation of the product. The warranty commences from date of sale to the end user for the following period:

CONSUMER/NON-COMMERCIAL APPLICATIONS:

Stainless Steel Components	5 Years
Gas Valve, Spark Igniter & Electronic Parts	2 Years
Log Sets	3 Years
Glass Windshields	5 Years
Glass Media	1 Year
Controls	5 Years
AnF Enclosures	5 Years
GFRC (Glass Fiber Reinforced Concrete)	1 Year

Lava Rock and Lava Stones are not covered by warranty

COMMERCIAL APPLICATIONS:

Stainless Steel Components	1 Year
Gas Valve, Spark Igniter & Electronic Parts	1 Year
Log Sets	1 Year
Glass Windshields	1 Year
Glass Media	1 Year
Controls	1 Year
AnF Enclosures	1 Year
GFRC (Glass Fiber Reinforced Concrete)	1 Year

Lava Rock and Lava Stones are not covered by warranty

End User must provide a bill of sale, canceled check, or payment record from the end user to verify purchase date and to establish warranty period. This Limited Warranty shall be valid and limited to the original purchaser only.

WARNING Any modification to the product will void the warranty.

This Limited Warranty shall be limited to the repair and/or replacement of parts that have proven to be defective under normal use and service. Before returning any parts, contact our Technical Service Department for a Return Materials Authorization (RMA) number. All warranty claims must be made by the OEM / Distributor / Dealer account on behalf of the end user. You may contact Technical Service at (855) 498-8324.

All approved returned defects must be confirmed by our Technical Service Department. If the defect is confirmed and we approve the claim, we will replace such parts without charge. This warranty gives you specific legal rights, and you may also have other rights, which vary from state to state.

Travel, diagnostic cost, service labor to repair the defect and freight charges on warranty parts to and from the factory will be responsibility of the owner. We will not be responsible for labor charges and/or damage incurred in installation, repair, and replacement.

This Limited Warranty is voided if not assembled, installed and operated as intended. This Limited Warranty does not cover any defects due to accident, abuse, misuse, alteration, misapplication, vandalism, improper installation or improper maintenance or service, removal from the original location or re- installation into another location, or failure to perform normal and routine maintenance.

Damage due to severe weather conditions such as hail, hurricanes, earthquakes, tornadoes, discoloration due to overheating, exposure to chemicals (including salt), either directly or in the atmosphere, or very high humidity, is not covered by this Limited Warranty.

There are no other express warranties except as set forth herein. For consumer applications, any applicable implied warranties of merchantability and fitness are limited in duration to the period of coverage of this Limited Warranty. Some states do not allow limitation on how long an implied warranty lasts, so this limitation may not apply to you.

For Commercial applications, the liability of Firegear Outdoors is limited to the express terms of this warranty. We expressly disclaim any and all implied warranties, including any warranties of fitness for a particular purpose or merchantability.

We are not liable for any special, indirect or consequential damages. Our maximum liability is limited to the purchase price of the purchased products. Some states do not allow the exclusion or limitation of incidental or consequential damages, so this limitation or exclusions may not apply to you.

We do not authorize any person or company to assume for it any other obligation or liability in connection with the sale, installation, use, removal, return, or replacement of its equipment; and no such representations are binding.

REV. 6/18





Having problems getting the fire pit to operate? Don't leave the job site!
We want to help! Call 855.498.8324 for Technical Support
between the hours of 8:00AM to 5:00PM EST.
Text photos to 260.255.5750 or e-mail photos to support@skytechpg.com.

BEFORE YOU CALL WE WILL NEED THIS INFORMATION

1. Model Number: _____
2. Serial Number: _____
3. How long is the gas line run? Nat Gas ____ LP Gas ____
4. What size is gas line? _____
5. Inlet Gas Pressure: _____ WC
Manifold Gas Pressure: _____ WC
6. What type of media are you using? _____
7. Review the troubleshooting section in the installation manual.
8. What are the symptoms? Please be prepared to explain.
9. Be prepared to send photos to us when on the phone.
10. Found missing or damaged parts? Let us know ASAP or send photos.